

SmoothHoodCoversForRestoration-3-DMoldedHoodCoversForThatCustomLook

Under Hood Covers are manufactured to cover the structural ribs on the under side of the hood surface of your vehicle to give a clean, finished look to the engine compartment.

## Tough, High Temperature ABS Cover with HeatShield Insulation Panels Pre-Cut, Ready to Install Kits

Mounting Pins and Illustrated Instructions included  
Year, Make and Model Specific

Compare the insulation patterns and images in this catalog to the under hood structure on your vehicle.

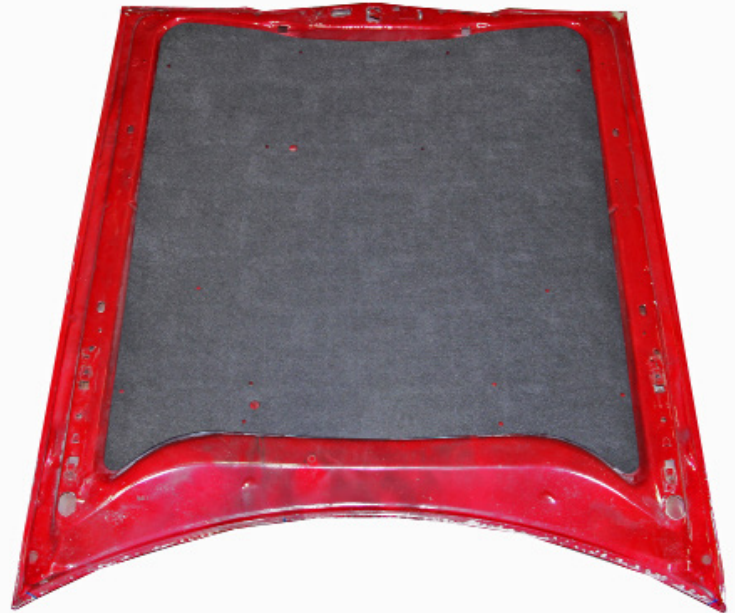

Watch our "How To" video on the Installation of a typical Under Hood Cover and Insulation

Go to: [youtube.com/quietridesolutions](http://youtube.com/quietridesolutions)

Order Online

AcoustiShield Catalog



Order Line: 888-777-3410  
Tech Line: 209-942-4777  
3183 Hwy 71 S, Mena, AR 71953

# Thunderbird 1955-57

## ABS Hood Cover And AcoustiShield

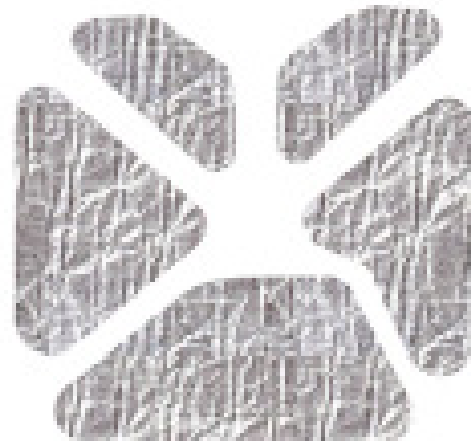
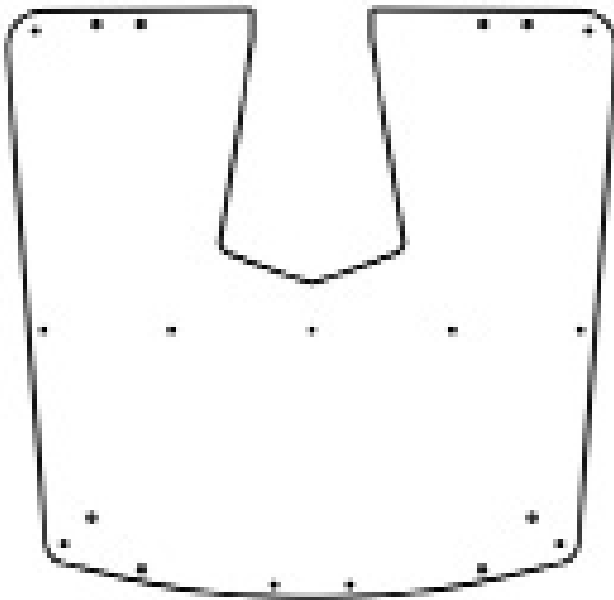
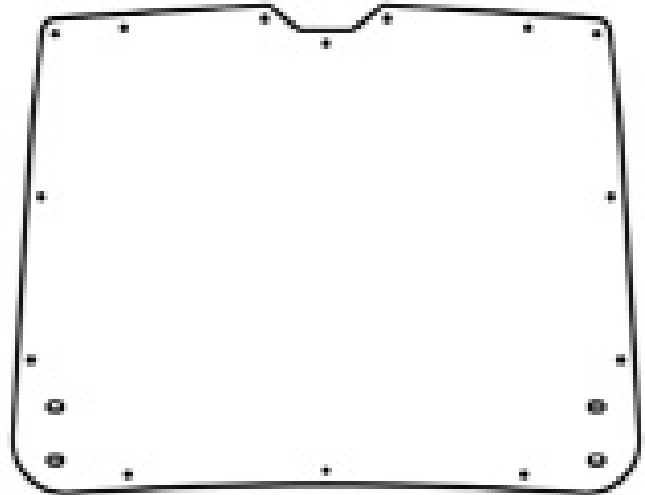

1957 Thunderbird  
Trunk Deck

Part #	Description	MSRP
<b>Hood</b>	<b>1955-57 Thunderbird</b>	
TBIRD 5557-CUHC	1955-57 Ford Thunderbird Under Hood Cover-Smooth	224.25
<b>Trunk</b>		
TBIRD 5700-CUTC	1957 Ford Thunderbird Under Trunk Cover-Smooth	131.10

# Thunderbird 1958-60

## ABS Hood Cover And AcoustiShield

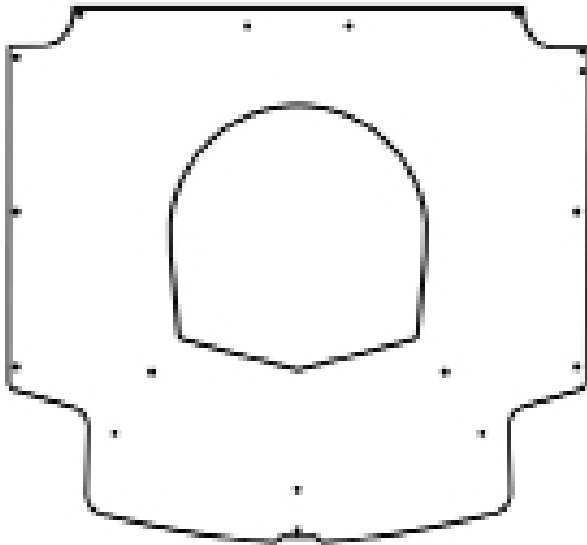
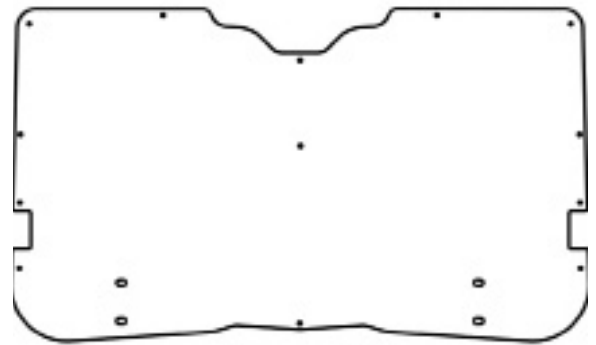
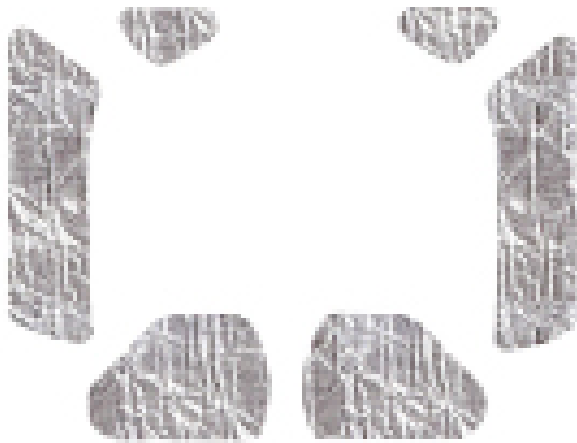

Part #	Description	MSRP
<b>Hood</b>	<b>1958-60 Thunderbird</b>	
TBIRD 5860-CUHC	1958-60 Ford Thunderbird Under Hood Cover-Smooth	224.25
<b>Trunk</b>		
TBIRD 5860-CUTC	1958-60 Ford Thunderbird Under Trunk Cover-Smooth	131.10

# Thunderbird 1961-63

## ABS Hood Cover And AcoustiShield

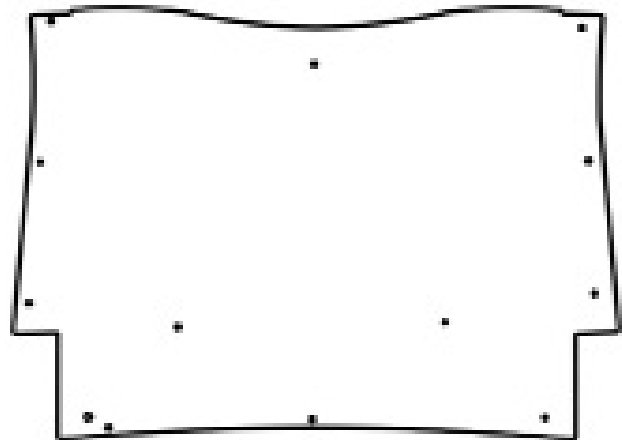
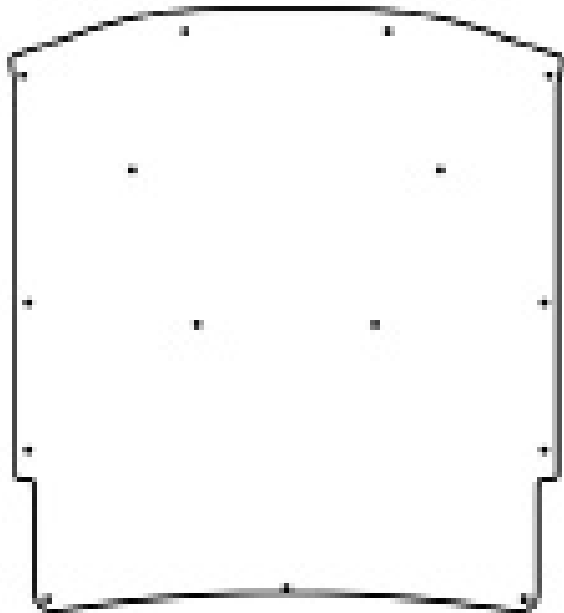

Part #	Description	MSRP
<b>Hood</b>	<b>1961-63 Thunderbird</b>	
TBIRD 6163-CUHC	1961-63 Ford Thunderbird Under Hood Cover-Smooth	224.25
<b>Trunk</b>		
TBIRD 6163-CUTC	1961-63 Ford Thunderbird Under Trunk Cover-Smooth	131.10

# Thunderbird 1964-66

## ABS Hood Cover And AcoustiShield

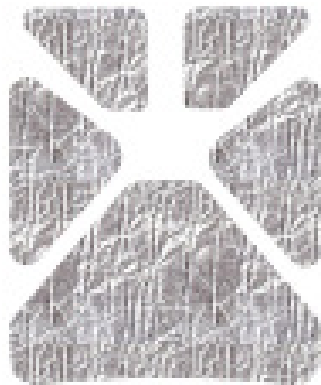
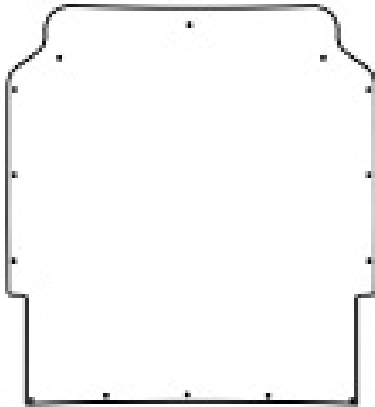

TBIRD 6465-CUHC

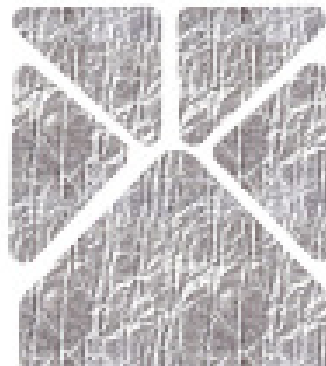
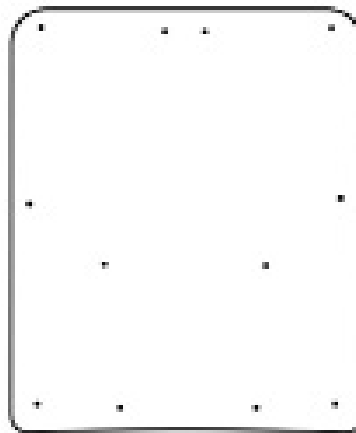

TBIRD 6600-CUHC

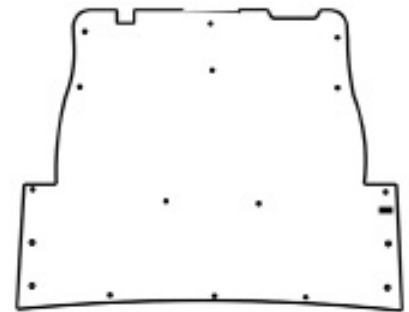

TBIRD 6466-CUTC

Part #	Description	MSRP
<b>Hood</b>	<b>1964-66 Thunderbird</b>	
TBIRD 6465-CUHC	1964-65 Ford Thunderbird Under Hood Cover-Smooth	224.25
<b>Hood</b>		
TBIRD 6600-CUHC	1966 Ford Thunderbird Under Hood Cover-Smooth	224.25
<b>Trunk</b>		
TBIRD 6466-CUTC	1964-66 Ford Thunderbird Coupe Under Trunk Cover-Smooth	131.10

# Thunderbird 1967-69

## ABS Hood Cover And AcoustiShield

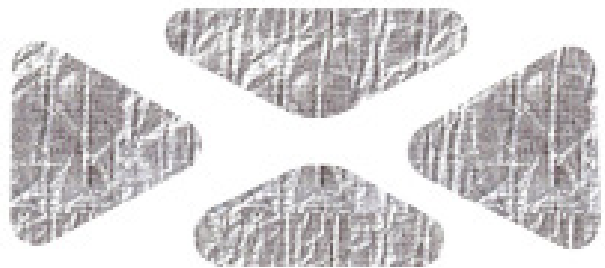
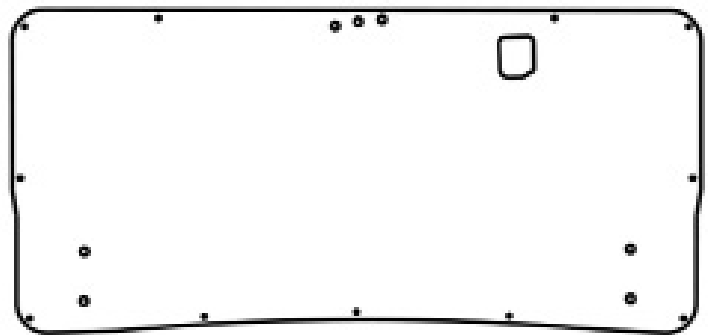
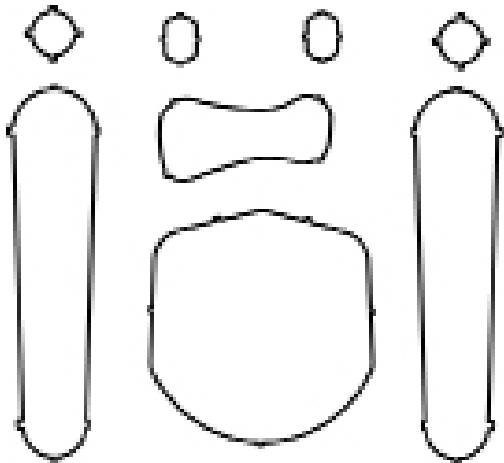

1967-69 Thunderbird  
Coupe Trunk Deck

Part #	Description	MSRP
<b>Hood</b>	<b>1967-69 Thunderbird</b>	
TBIRD 6769-CUHC	1967-69 Ford Thunderbird Under Hood Cover-Smooth	224.25
<b>Trunk</b>		
TBIRD 6769-CUTC	1967-69 Ford Thunderbird Under Trunk Cover-Smooth	131.10

# Thunderbird 1977-79

## ABS Hood Cover And AcoustiShield

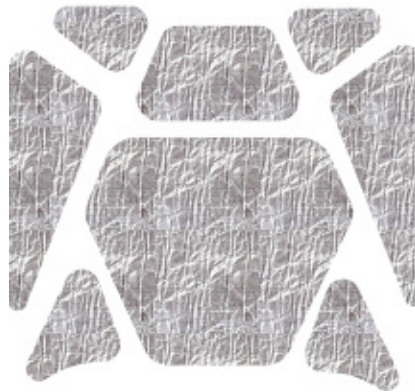
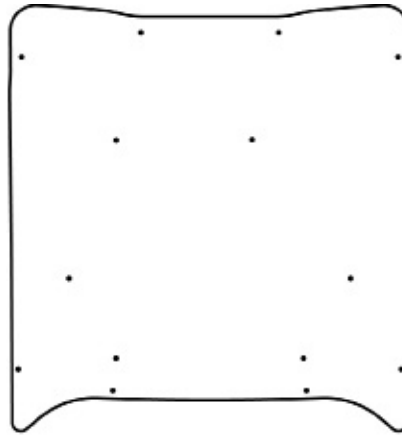

Part #	Description	MSRP
<b>Hood</b>	<b>1977-79 Thunderbird</b>	
TBIRD 7779-CUHC	1977-79 Ford Thunderbird Under Hood Cover-Smooth	224.25



**WARNING**  
Cancer and  
Reproductive Harm  
[www.p65Warnings.ca.gov](http://www.p65Warnings.ca.gov)

### Product Information/Disclaimer

- The high temp ABS material will regularly tolerate temperatures up to 250 degrees.
- Air flow is the important factor in heat dissipation.
- Be certain to maintain at least one inch (or more) of clearance between the surface of the under hood cover and engine components like air cleaner covers.
- Some Steel hoods may require the drilling of hood cover mounting holes. Instructions are included in the kit.
- Hood Covers on fiberglass hoods are mounted with magnetic fasteners which are glued in place. Instructions are included in the kit.

**QuietRide Solutions will not be responsible for improperly installed under hood covers.**