

Roof to Road Solutions to Control Passenger Cabin Noise, Vibration and Heat

- Reduce Road Noise
- Reduce Exhaust Harmonics
- Eliminate Mechanical Noise
- Stop Body Panel Vibration
- Reduce Radiated & Reflected Heat
- Stop Audio System Vibration

Pre-Cut Ready to Install Kits
Year • Make • Model Specific

The Coolest Cars Have QuietRIDE Inside!™



Order Online



1970 Challenger
Coupe



1967-68 Mustang
Fastback

Cowl Kit

Panels between the firewall and front door of the vehicle.

Firewall Insulator

Fits under dash against the firewall bulkhead.

Roof Kit

Roof & Quarter Panels above Beltline.

Trunk Floor Kit

Trunk Floor & Tire Well

Door Kit

All Doors

Floor Kit

Front Floor, Rear Floor, Transmission Hump/ Driveline

Body Panel Kit

All Panels below the beltline including Package Tray, Seat Divider, Rear Wheel Wells, Fenders, Rear Quarters and Tail Panels

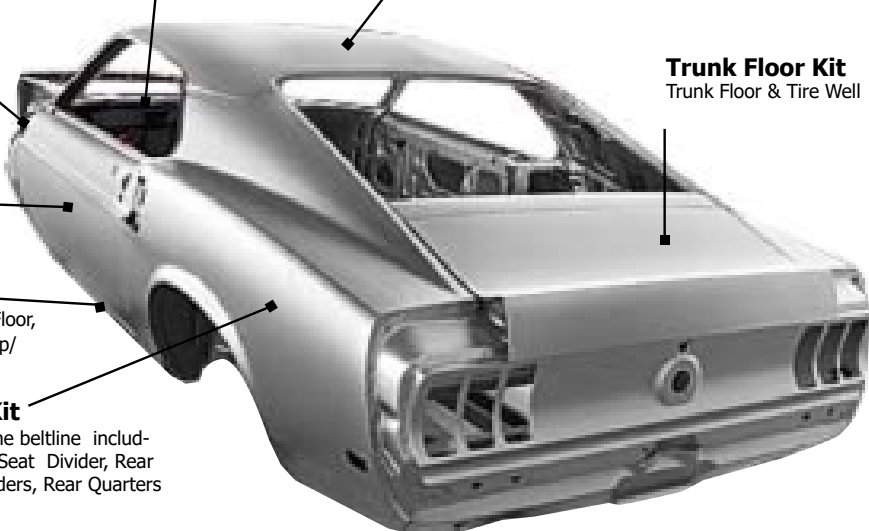

1947-54 Chevy
Truck



1955-57 Chevy
Truck

1969 Mustang
Fastback



1970 Chevell
Coupe



1970 Chevell
Convertible



1969 Camaro/Firebird
Convertible



1969 Camaro/Firebird
Coupe

Everything in One Box to Do the Job Right!

Pre-Cut, Ready To install Kits are Year, Make and Model Specific and include:

- AcoustiShield Damper Pads
- Heat Shield Barrier Insulation
- Spray Adhesive •Seam Tape
- Illustrated Instructions



Order Line: 888-777-3410

Tech Line: 209-942-4777

Fax: 877-720-2360

3183 Hwy 71 S, Mena, AR 71953

For more information contact us at: info@quietride.com

©2003-21 •Prices Subject to Change Without Notice



AcoustiSHIELD[®]

Automotive Thermal Acoustic Insulation

Roof to Road Solutions to Control Passenger Cabin Noise, Vibration and Heat

Introducing a multi-stage, automotive insulation and sound dampening system to give Dynacorn cars and Trucks the “quiet riding comfort” found in today’s new cars. AcoustiSHIELD kits are designed with current “state-of-the-art” auto acoustic technology, to insulate and control the noise, vibration and heat in the passenger cabin. Kits are pre-cut and come with easy-to-follow installation instructions-----everything you need to do the job right.

DYNACORN

CLASSIC BODIES INC.

Replacement Body Shells

www.dynacornclassicbodies.com

Phone: 805-486-2612

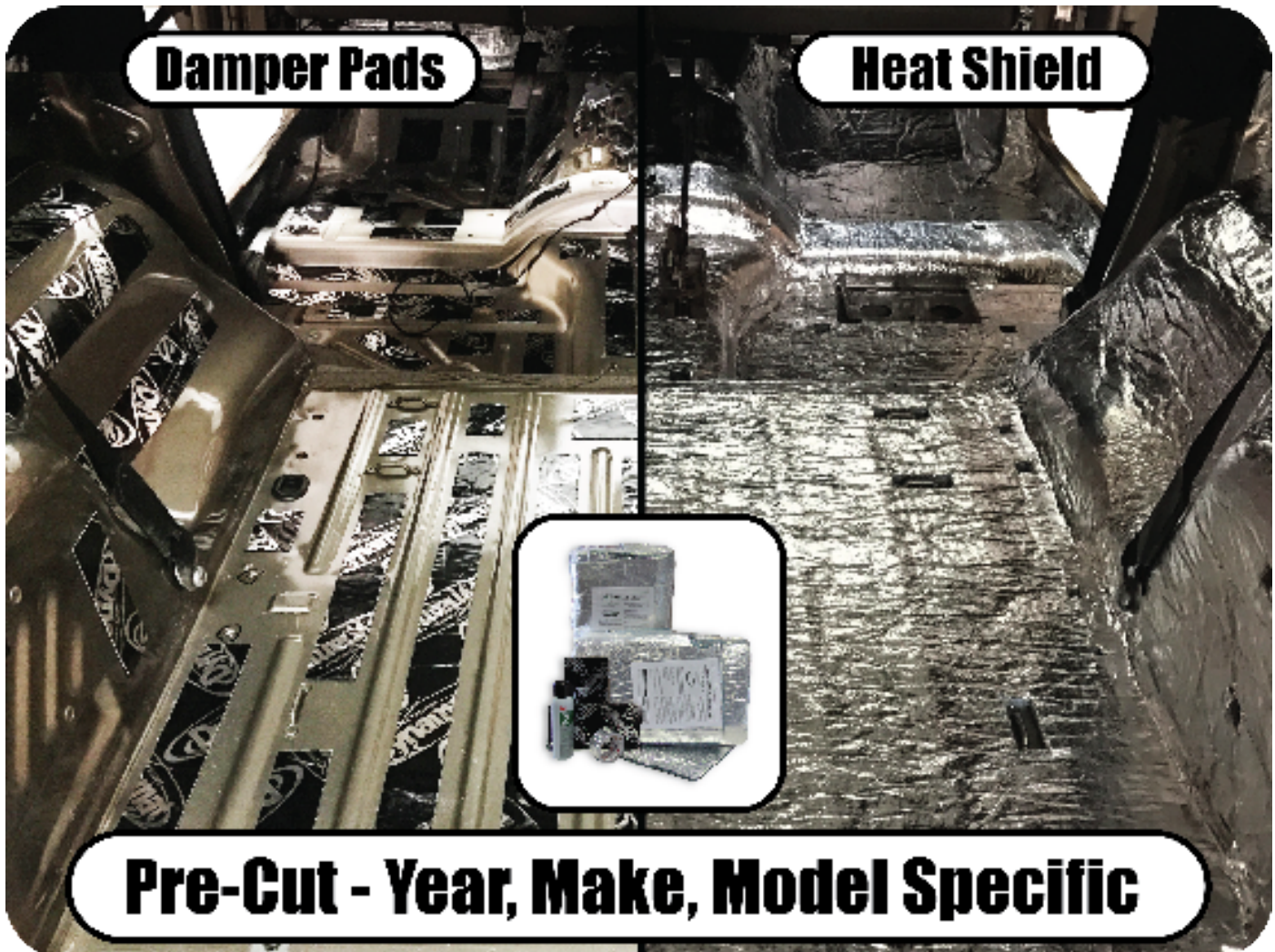

Dynacorn 1964-66 Mustang Convertible

AcoustiSHIELD® Pre Cut Kits Ready to Install

Product Application Codes and Price Sheet

1964-66 Dynacorn Mustang Fastback

MUST 6466-CVAK	1964-1966 Mustang Convertible Complete Acoustic Insulation Kit	798.10
MUST 6466-FCCCK	1964-66 Mustang FB/Coupe/Convert Cowl Insulation Kit	103.50
MUST 6466-FCCFK	1964-66 Mustang FB/Coupe/Convert Floor Insulation Kit	307.05
MUST 6466-FCCTFK	1964-66 Mustang FB/Coupe/Convert Trunk Floor Insulation Kit	187.45
MUST 6466-CVBPK	1964-66 Mustang Convert Body Panel Insulation Kit	171.35
MUST 6466-CVDBIK	1964-1966 Mustang Convert 2-Door Damper Barrier Insulation Kit	78.20



"Assembled with pride in the U.S.A."

Related Products for this Car (Sold Separately)







MUST 6466-CVSD	1964-66 Mustang Convertible Seat Divider/Insulated	154.10
MUST 6466-C	1964-1966 Mustang Firewall Insulator Panel	253.00
MUST 6468-TPCD	1964-1968 Mustang Trunk Pocket Cover DRIVER SIDE	65.55
MUST 6468-TPCP	1964-1968 Mustang Trunk Pocket Cover PASS SIDE	65.55

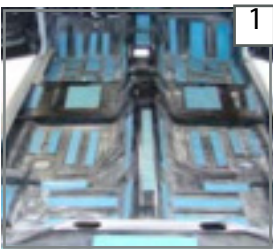

Must 6466-HC Firewall Insulator-Heater

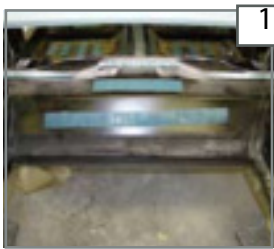
AcustiTRUNK®
&
AcustiHOOD

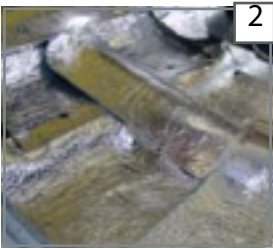
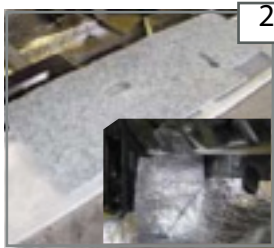
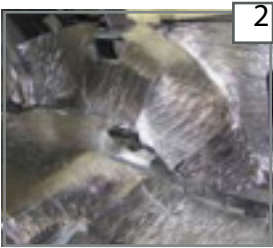
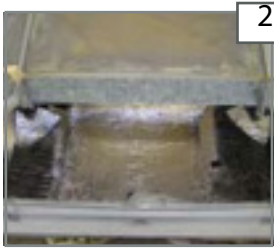
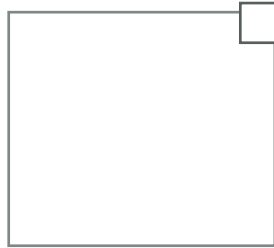
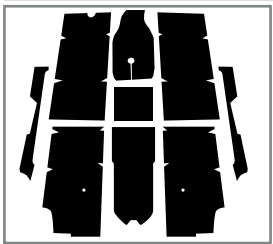
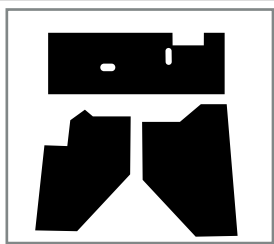
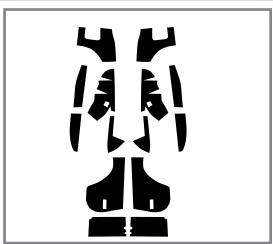
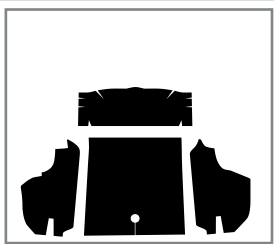
Kits are available for this vehicle.

Floor	Cowl	Body	Trunk	
 1	N/A	 1	 1	
 2	 2	 2	 2	
				

Dynacorn 1967-68 Mustang Fastback

AcoustiSHIELD® Pre Cut Kits Ready to Install

Product Application Codes and Price Sheet

1967-68 Dynacorn Mustang Fastback

MUST 6768-FBAK	1967-68 Dynacorn Mustang FB Complete Acoustic Insulation Kit	972.90
MUST 6768-FBBPK	1967-68 Dynacorn Mustang FB Body Panel Insulation Kit	171.35
MUST 6768-FBCK	1967-68 Dynacorn Mustang FB Cowl Insulation Kit	187.45
MUST 6768-FBTFK	1967-68 Dynacorn Mustang FB Trunk Floor Insulation Kit	103.50
MUST 6768-FBFBK	1967-68 Dynacorn Mustang FB Floor Insulation Kit	307.05
MUST 6768-FBRK	1967-68 Dynacorn Mustang FB Roof Insulation Kit	187.45
MUST 6768-FBDBIK	1967-1968 Mustang FB 2-Door Damper Barrier Shield Kit	78.20



"Assembled with pride in

Related Products for this Car (Sold Separately)







MUST 6768-AC	1967-68 Dynacorn Mustang Firewall Insulator Panel	253.00
MUST 6768-TLC	1967-68 Mustang Shelby Tail light Cover Set	266.80

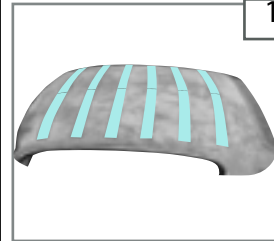

Must 6768-AC Firewall Insulator-Factory AC

AcoustiTRUNK®
&
AcoustiHOOD®

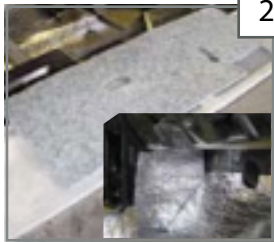
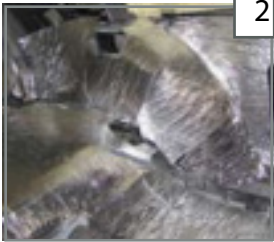
Kits are available for this vehicle.

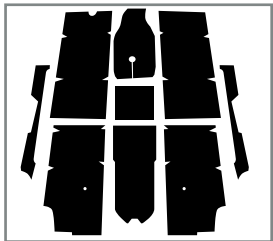
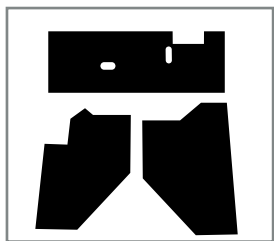
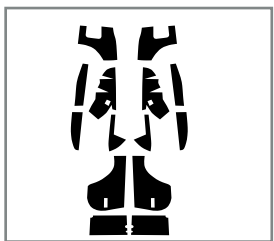
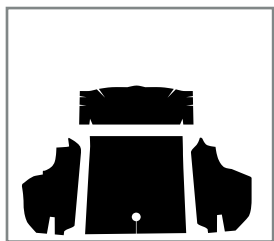
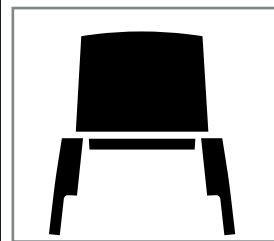
Floor	Cowl	Body	Trunk	Roof
	N/A			
				
				

Dynacorn 1967-68 Mustang Convertible

AcoustiSHIELD® Pre Cut Kits Ready to Install

Product Application Codes and Price Sheet

1967-68 Dynacorn Mustang Fastback

MUST 6768-CVAK	1969-70 Mustang Convertible Complete Acoustic Insulation Kit	798.10
MUST 6768-FCCCK	1969-70 Mustang FB/Coupe/Convert Cowl Insulation Kit	103.50
MUST 6768-FCCFK	1969-70 Mustang FB/Coupe/Convert Floor Insulation Kit	307.05
MUST 6768-FCCTFK	1969-70 Mustang FB/Coupe/Convert Trunk Floor Insulation Kit	187.45
MUST 6768-CVBPK	1969-70 Mustang Convert Body Panel Insulation Kit	171.35
MUST 6768-CVDBIK	1969-1970 Mustang Convert 2-Door Damper Barrier Kit	78.20



"Assembled with pride in

Related Products for this Car (Sold Separately)









MUST 6768-CVSD	1969-70 Mustang Convert Seat Divider/Insulated	154.10
MUST 6768-C	1969-1970 Mustang Firewall Insulator Panel	253.00
MUST 6768-CM1	1969-1970 Mustang Mach-1 Firewall Insulator Panel	253.00

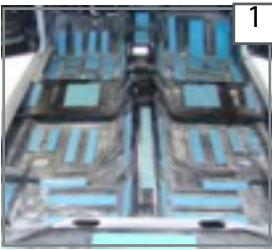

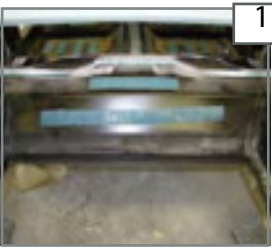
Must 6768-AC Firewall Insulator-Factory AC

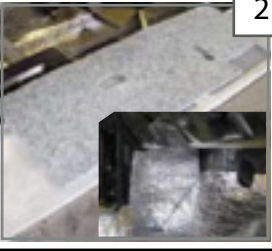
AcoustiTRUNK®
&
AcoustiHOOD

Kits are available for this vehicle.

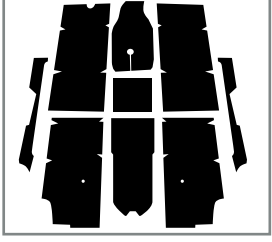
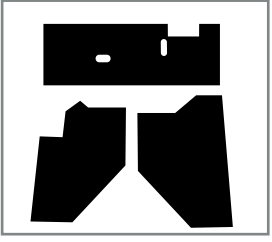
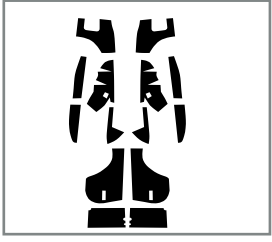
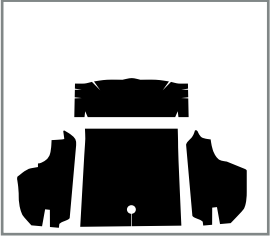
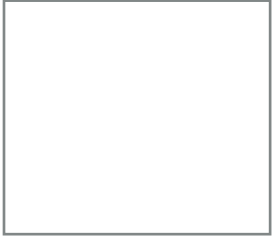
Floor	Cowl	Body	Trunk	
 1	N/A	 1	 1	
 2	 2	 2	 2	
				

Dynacorn 1969-70 Mustang Fastback

AcoustiSHIELD® Pre Cut Kits Ready to Install

Product Application Codes and Price Sheet

Inventory #	Description	Price
1969-70 Dynacorn Mustang Fastback		
MUST 6970-FBAK	1969-70 Dynacorn Mustang FB Complete Kit	972.90
MUST 6970-FBBPK	1969-70 Dynacorn Mustang FB Body Panel Kit	171.35
MUST 6970-FBCK	1969-70 Dynacorn Mustang FB Cowl Kit	103.50
MUST 6970-FBFK	1969-70 Dynacorn Mustang FB Floor Kit	307.05
MUST 6970-FBRK	1969-70 Dynacorn Mustang FB Roof Kit	187.45
MUST 6970-FBTFK	1969-70 Dynacorn Mustang FB Trunk Floor Kit	187.45
MUST 6970-FBDBIK	1969-1970 Mustang FB 2-Door Damper Barrier Shield Kit	77.05

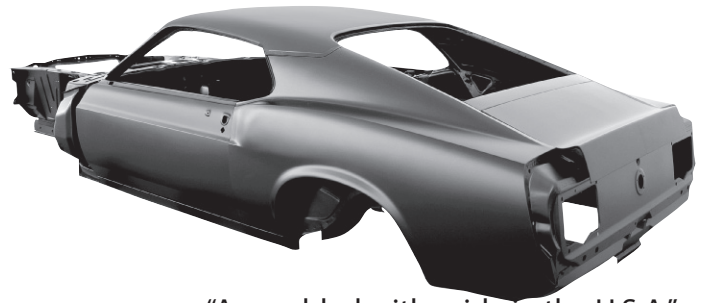

"Assembled with pride in the U.S.A."

Related Products for this Car (Sold Separately)











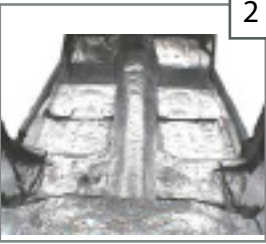

MUST 69710-CM1	1969-1970 Dynacorn Mustang Mach 1 Firewall Insulator w/Factory AC	253.00
----------------	-------------------------------------------------------------------	--------

AcoustiTRUNK®
&
AcoustiHOOD

Kits are available for this vehicle.

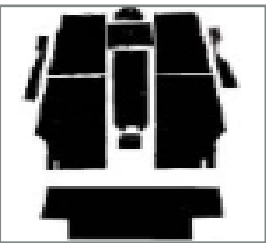
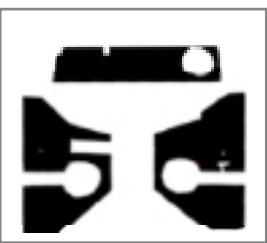

Must 6970-CM1 Firewall Insulator--Mach 1

Floor	Cowl	Body	Trunk	Roof
 1	N/A	 1	 1	 1
 2	 2	 2	 2	 2
				

1966-76 Bronco

AcoustiSHIELD™

Pre Cut Kits Ready to Install

Product Application Codes and Price Sheet

1966-76 Dynacorn Ford Bronco

BRONCO6676-FCTAK	1966-1976 Dynacorn Bronco Full Cab Complete Acoustic Insulation Kit	614.10
BRONCO6676-FCTCK	1966-1976 Dynacorn Bronco Full Cab Cowl Insulation Kit	156.40
BRONCO 6676-FCTFK	1966-1976 Dynacorn Bronco Full Cab Floor Insulation Kit	254.15
BRONCO6676-FCTRK	1966-1976 Dynacorn Bronco Full Cab Roof Insulation Kit	169.05
ASU-DDBIK-2	Universal 2 Door Damper Kit	77.05



Related Products for this Car (Sold Separately)

BRONCO 6677-T	1966-1977 Dynacorn Bronco Firewall Insulator Panel	246.10
BRONCO 6677-FCHK	1966-1977 Dynacorn Bronco Full Cab Roof Cover	289.80

Cowl Kit

Floor Kit

Roof Kit

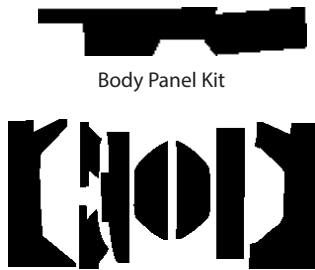

Body Panel Kit

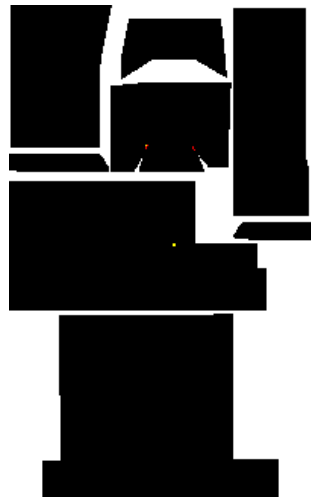

ASU-DDBIK-2 Universal 2-Door Damper/Barrier Insulation Kit For 2-door Coupes, Convertibles, Trucks with upholstered door panels. Includes AcoustiShield damper pads, Weather Barrier Insulation, double-sided foam tape and Instructions. Easy to Install.



Bronco 6677-T



ShowBEDDER®
Truck Bed Covers for Classic Trucks

&

AcoustiHOOD

Kits are available for this vehicle.

Dynacorn Challenger

AcoustiSHIELD® Pre Cut Kits Ready to Install

Product Application Codes and Price Sheet

1970 Challenger Coupe

Part #	Description	MSRP
MOPAR-E 7074-CAK	1970 Dynacorn Challenger E-Body Coupe Complete Acoustic Insulation Kit	898.15
MOPAR-E 7074-CBPK	1970 Dynacorn Challenger E-Body Coupe Body Panel Insulation Kit	169.05
MOPAR-E 7074-CCK	1970 Dynacorn Challenger E-Body Coupe Cowl Insulation Kit	66.70
MOPAR-E 7074-CFK	1970 Dynacorn Challenger E-Body Coupe Floor Insulation Kit	302.45
MOPAR-E 7074-CRK	1970 Dynacorn Challenger E-Body Coupe Roof Insulation Kit	169.05
MOPAR-E 7074-CTK	1970 Dynacorn Challenger E-Body Coupe Trunk Insulation Kit	169.05
ASU-DDBIK-2	Universal 2 Door Damper Kit	77.05



"Assembled with pride in

Related Products for this Car (Sold Separately)

MOPAR-E 7074-AC	1970 Dynacorn Challenger E-Body Car Firewall w/AC	90.85
MOPAR-E 7074-HC	1970 Dynacorn Challenger E-Body Car Firewall w/Heater	90.85



AcoustiTRUNK™

&

AcoustiHOOD

Kits are available for this vehicle.

Dynacorn Chevelle

AcustiSHIELD® Pre Cut Kits Ready to Install

Product Application Codes and Price Sheet

1970 Chevelle Coupe

GMA 6872-CAK	1970 Dynacorn GM-A Body Coupe Complete Acoustic Insulation Kit	933.80
GMA 6872-CBPK	1970 Dynacorn GM-A Body Coupe Body Panel Insulation Kit	166.75
GMA 6872-CCK	1970 Dynacorn GM-A Body Coupe Cowl Insulation Kit	116.15
GMA 6872-CFK	1970 Dynacorn GM-A Body Coupe Floor Insulation Kit	299.00
GMA 6872-CRK	1970 Dynacorn GM-A Body Coupe Roof Insulation Kit	166.75
GMA 6872-CTK	1970 Dynacorn GM-A Body Coupe Trunk Insulation Kit	166.75
ASU-DDBIK-2	Universal 2 Door Damper Kit	77.05



1970 Chevelle Convertible

GMA 6872-CVAK	1970 Dynacorn GM-A Body Convert Complete Kit	779.70
GMA 6872-CVBPBK	1970 Dynacorn GM-A Body Convert Body Panel Insulation Kit	166.75
GMA 6872-CVCK	1970 Dynacorn GM-A Body Convert Cowl Insulation Kit	116.15
GMA 6872-CVFK	1970 Dynacorn GM-A Body Convert Floor Insulation Kit	299.00
GMA 6872-CVTK	1970 Dynacorn GM-A Body Convert Trunk Insulation Kit	166.75
ASU-DDBIK-2	Universal 2 Door Damper Kit	77.05











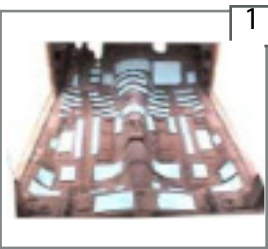





AcustiTRUNK™
&
AcustiHOOD

Kits are available for this vehicle.

Related Products for this Car (Sold Separately)

GMA 6872-AC	Chevelle Firewall Insulator with Factory AC	253.00
GMA 6872-HC	Chevelle Firewall Insulator with Heater	253.00

Floor	Cowl	Body	Trunk	Roof
 1	N/A	 1	 1	 1
 2	 2	 2	 2	 2
				

Dynacorn Camaro

AcoustiSHIELD® Pre Cut Kits Ready to Install

Product Application Codes and Price Sheet

1969 Dynacorn Camaro/Firebird Coupe

GMF 6769-CAK	1969 Dynacorn Camaro Coupe Complete Acoustic Insulation Kit	946.45
GMF 6769-CBPK	1969 Dynacorn Camaro Coupe Body Panel Kit	169.05
GMF 6769-CCK	1969 Dynacorn Camaro Coupe Cowl Kit	117.30
GMF 6769-CFK	1969 Dynacorn Camaro Coupe Floor Kit	302.45
GMF 6769-CRK	1969 Dynacorn Camaro Coupe Roof Kit	169.05
GMF 6769-CTFK	1969 Dynacorn Camaro Coupe Trunk Floor Kit	169.05
ASU-DDBIK-2	Universal 2 Door Damper Kit	77.05



1969 Dynacorn Camaro/Firebird Convertible







GMF 6769-CVAK	1969 Dynacorn Camaro Convertible Complete Acoustic Insulation Kit	788.90
GMF 6769-CVBPk	1969 Dynacorn Camaro Convert Body Panel Kit	169.05
GMF 6769-CVCK	1969 Dynacorn Camaro Convert Cowl Kit	117.30
GMF 6769-CVFK	1969 Dynacorn Camaro Convert Floor Kit	302.45
GMF 6769-CVTFK	1969 Dynacorn Camaro Convert Trunk Floor Kit	169.05
ASU-DDBIK-2	Universal 2 Door Damper Kit	77.05

Related Products for this Car (Sold Separately)

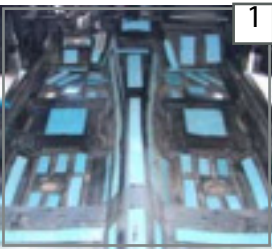
GMF 6769-AC	1969 Dynacorn Camaro Firewall Insulator Panel	253.00
-------------	-----------------------------------------------	--------

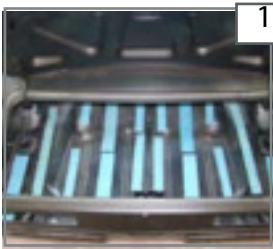
AcoustiTRUNK®
&
AcoustiHOOD

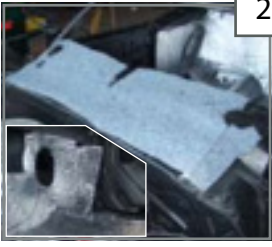
Kits are available for this vehicle.

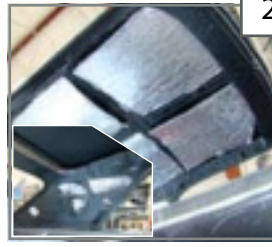
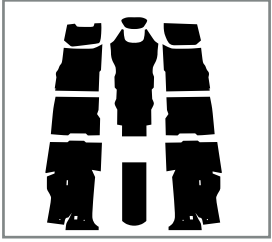
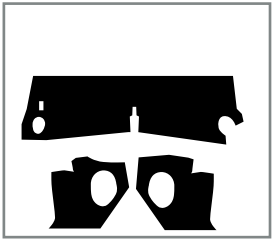
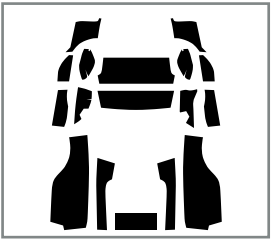
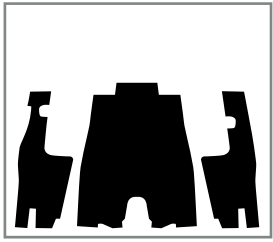
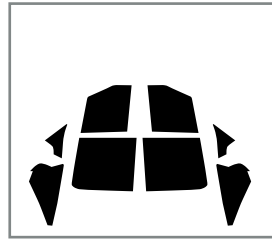
Floor	Cowl	Body	Trunk	Roof
 1	N/A	 1	 1	 1
 2	 2	 2	 2	 2
				

Dynacorn 1947-50 Chevrolet Truck

AcoustiSHIELD® Pre Cut Kits Ready to Install

Product Application Codes and Price Sheet

1947-53 Dynacorn Chevrolet Truck

CHEV 4753-TAK	1947-1950 Dynacorn Chevy Truck Complete Kit	658.95
CHEV 4753-TCK	1947-1950 Dynacorn Chevy Truck Cowl Kit	134.55
CHEV 4753-TFK	1947-1950 Dynacorn Chevy Truck Floor Kit	236.90
CHEV 4753-TRCK	1947-1950 Dynacorn Chevy Truck Rear Cab Kit	134.55
CHEV 4753-TRK	1947-1950 Dynacorn Chevy Truck Roof Kit	134.55
ASU-DSD-2	Universal 2 Door Damper Kit	77.05



Related Products for this Car (Sold Separately)











CHEV 4753-T	1947-1953 Dynacorn Chevy Truck Firewall	286.35
BIT 4754SBC-T3	1947-1954 Bitchin Chevrolet Truck Sml. Block Firewall 3" Setbk	286.35
DS 4754BBC-T5	1947-1954 Direct Shtmetal Chevy Truck Big Block Firewall 5" Setbk	286.35
CHEV 4753-TSP	1947-1954 Dynacorn Chevy Truck Cowl Panel Set	101.20
CHEV 4753-TDP	1947-1954 Dynacorn Chevy Truck Door Panel Set	120.75
CHEV 5053-THO2	1950-1953 Dynacorn Chevy Truck Two-Piece Original Style Headliner	147.20
CHEV 4753-THM	1947-1953 Dynacorn Chevy Truck Molded Headliner	282.90



ShowBEDDER®
Truck Bed Covers for Classic Trucks

&
AcoustiHOOD

Kits are available for this vehicle.

Floor	Cowl	Rear Cab	Roof
 <p>1</p>  <p>2</p> 	<p>1N/A</p>  <p>2</p> 	<p>1</p>  <p>2</p>  	 <p>1</p>  <p>2</p> 

Dynacorn 1955-57 Chevrolet Truck

AcoustiSHIELD® Pre Cut Kits Ready to Install

Product Application Codes and Price Sheet

1955-57 Dynacorn Chevrolet Truck

CHEV 5559-TAK	1955-1957 Dynacorn Chevy Truck Complete Acoustic Insulation Kit	595.70
CHEV 5559-TCK	1955-1957 Dynacorn Chevy Truck Cowl Insulation Kit	134.55
CHEV 5559-TFK	1955-1957 Dynacorn Chevy Truck Floor Insulation Kit	236.90
CHEV 5559-TRCK	1955-1957 Dynacorn Chevy Truck Rear Cab Insulation Kit	134.55
CHEV 5559-TRK	1955-1957 Dynacorn Chevy Truck Roof Insulation Kit	66.70
ASU-DDBIK-2	Universal 2 Door Damper Kit	77.05



"Assembled with pride in the U.S.A."











Related Products for this Car (Sold Separately)

CHEV 5559-T	1955-1957 Dynacorn Chevy Truck Firewall	261.05
CHEV 5559-TH	1955-1957 Dynacorn Chevy Truck Headliner Cover	108.10

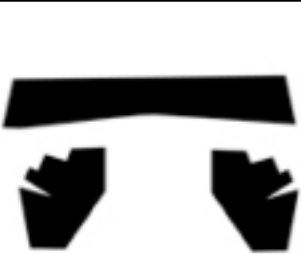
AcoustiTRUNK®
&
AcoustiHOOD

Kits are available for this vehicle.



Floor	Cowl	Rear Cab	Roof
 <p>1</p>  <p>2</p> 	 <p>1</p>  <p>2</p>	 <p>1</p>  <p>2</p> 	 <p>1</p>  <p>2</p> 



AcoustiSHIELD®

Automotive Thermal Acoustic Insulation



A Roof to Road Solution to Control Passenger Cabin Noise, Vibration and Heat™

AcoustiSHIELD Product Description

AcoustiShield is a two-stage thermal acoustic automotive insulation product designed to control Noise, Vibration and Heat—the three major issues that affect passenger cabin comfort. Kits include pre-cut, ready-to-install AcoustiShield damper pads and HeatShield Barrier Insulation panels which are packaged separately for easy installation. Kits come with uniquely illustrated installation sheets, spray adhesive and seam tape.



Complete Acoustic Kits insulate the **Cowl, Floor, Roof, Trunk Floor, Doors and Body Panels**, which includes the seat divider, package tray and rear wheel wells. The installation of a complete AcoustiShield kit typically will reduce passenger cabin noise by 12 to 17 decibels. To put this in perspective, a 10-decibel reduction is a 50 percent reduction in noise that the human ear can easily detect. Barrier insulation will reduce radiant heat by as much as 25 degrees.

AcoustiShield is a Two-Stage Process

Stage-One of the AcoustiShield process is the application of small pre-cut AcoustiShield damper pads and strips to auto body sheet metal to greatly reduce the vibration and noise produced by these panels from entering the passenger cabin.

Stage-Two of the AcoustiShield process is the application of pre-cut HeatShield Barrier Insulation panels to the auto body sheet metal to encapsulate any remaining vibration/noise and to thermally insulate the vehicle.



WARNING
Cancer and
Reproductive Harm
www.p65Warnings.ca.gov

©2003-21 Quiet Ride Solutions LLC.

“AcoustiSHIELD” --- “Quiet Ride Solutions” “AcoustiTRUNK” ---”ShowBEDDER” ---”AcoustiHOOD”are Registered Trade Marks of Quiet Ride Solutions LLC.

Expanded NVH Reference Information:

Cars and trucks make and/or absorb noise, vibration and heat (NVH) from multiple directions--including internal and external air-borne noise, structure-borne noise as well as radiant heat. NVH factors to consider:

- Engine NVH travels back from the front of the vehicle through the firewall and cowl.
- Wheel well trunk and rear body panel NVH travels forward through the seat divider and package tray panels.
- Roadway radiant heat, often exceeding 140 degrees, rises through vehicle floor pans.
- Rumbling performance exhaust systems and transmission/drive line harmonics also rise through vehicle floor pans.
- Direct heat from the sun penetrates the roof of the vehicle.

All of these influences “Apex” in the middle of the passenger cabin at ear level.

Add the noise produced by the sound system; the air rushing through the vents from the HVAC system; and a normal conversation builds into a “shouting match” between the driver and passenger to overcome the “harmonic drone” of vehicle mechanics.

AcustiShield Photo Gallery



Typical Cowl Panel Sound Dampening and Thermal Barrier Insulation.

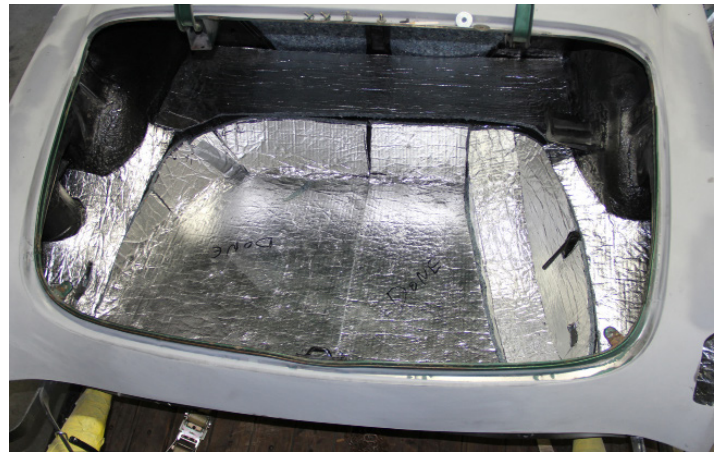

Typical Trunk Floor Sound Dampening and Thermal Barrier Insulation.



Typical Floor Panel Sound Dampening and Thermal Barrier Insulation.



Typical Roof Panel Sound Dampening and Thermal Barrier Insulation.



Typical Body Panel Sound Dampening and Thermal Barrier Insulation.



Firewall **INSULATORS**™

Stop Engine Heat at the Source

**Made Right---Fit Right---Look Right
OEM Original Products**



ABS Leather Grain Material

Firewall Insulator products are pre-cut and ready to install with standard OEM accessory and mounting holes punched for restoration applications. Each unit has period correct insulation.

Firewall Insulators are also available without holes for aftermarket HVAC systems and Street Rod and Custom installs.



**“Ultra High Definition”
Vinyl Rubber**

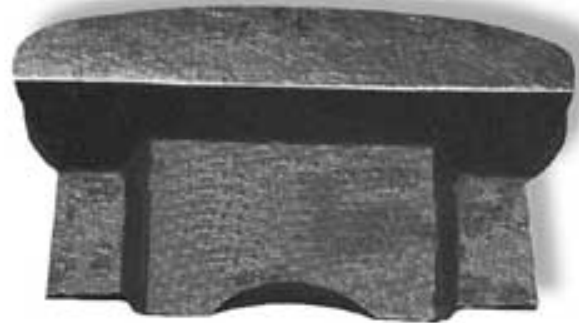

**Street Rod Firewall Insulator
Direct Sheetmetal
Absolute Sheetmetal**

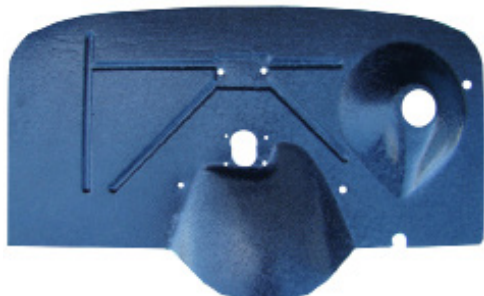

ABS “Chicken Track” Material

Quick Link



Product Description—

ABS “Leather Grain”

Original Equipment Firewall Insulators

Production Period—GM and MOPAR: 1926 through 1976

Production Period—FOMOCO: 1949 through 1979

ABS Firewall Cover Leather Grain Material

Most OEMs used a leather grained firewall cover on their cars and trucks from 1926 through 1965. Each insulator product is molded with ABS material and ready-to-install with factory stock accessory holes and mounting pin locations punched.

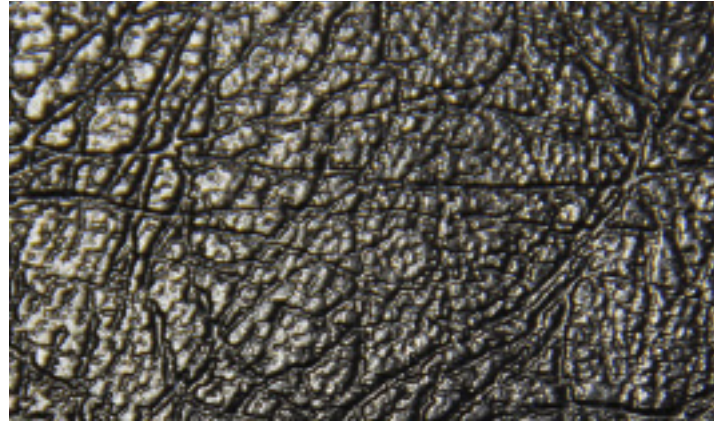

Kits does not include mounting pins. Quiet Ride has an assortment of “universal” mounting pin styles available as needed.

Mounting pins are not included but are available for separate purchase as needed.

Each insulator product is molded from an “out of the car” original firewall for contour and accuracy.

Year-Make-Model Specific.

Firewall Insulators can be ordered without holes for custom applications.

Product Description—

“Ultra High Definition Vinyl Rubber“

Original Equipment Firewall Insulators

for General Motors Cars and Ford Cars and Trucks

Production Period—GM: 1964 to present

Production Period—FOMOCO: 1964 to present

FOMOCO and General Motors began using a rubber based firewall material in 1964 with the introduction of the Mustang, Chevelle family and Camaro Cars. Quiet Ride molds these products using a “Ultra High Definition” vinyl rubber. It comes ready to install with a Heat Shield Thermal Barrier insulation pad. Factory stock accessory holes and mounting pin locations are punched.

Kits include appropriate period mounting pins.

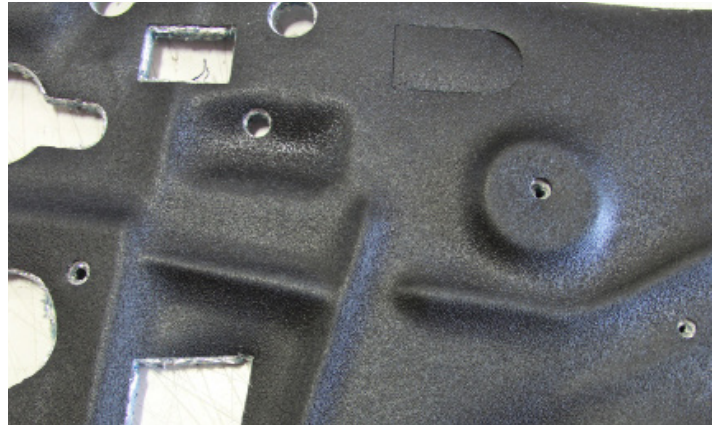

**Each insulator product is
molded from an “out of the car”
original firewall for contour and
accuracy.
Year-Make-Model Specific.**

**Firewall Insulators can be ordered without holes for
custom applications.**

Thermal Insulation Types

Original Equipment Firewall Insulators

- General Motors Cars and Trucks
- Ford Cars and Trucks
- MOPAR Cars and Trucks

Black Fiberglass Insulation

Typically used in vehicles 1949 through 1977

- ABS Firewall Insulators

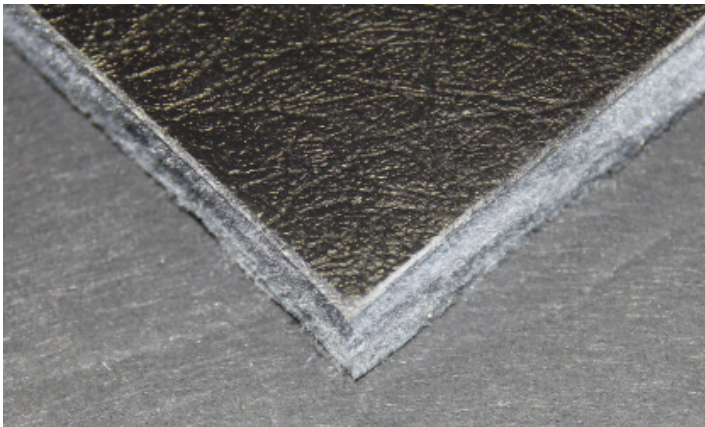

Heat Shield Barrier Insulation

Typically used in vehicles 1928-48 and Vinyl Rubber Firewalls 1964-present

- Street Rods
- Custom Firewalls

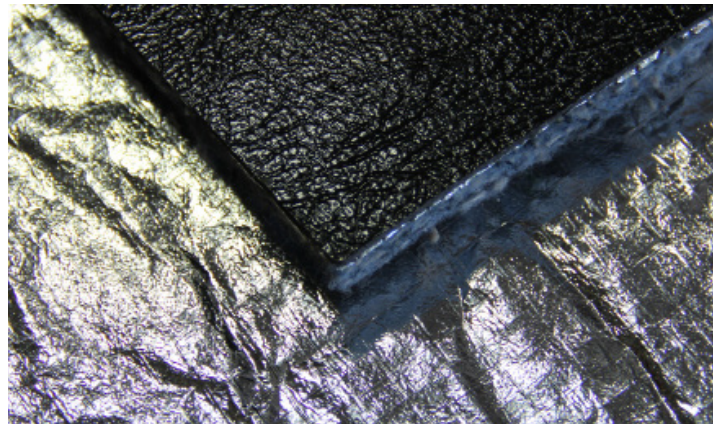

Concours Show Quality

Authentically Correct---“Fit like a Glove”---Easy to Install

All QRS Products, Materials and Craftsmanship
Meet or Exceed OEM Quality Standards

No customer has ever reported losing judged points on our firewall products.

Firewall Insulators--A Historical Perspective

The Firewall Insulator is the first line of defense against automotive Noise, Vibration and Heat that is generated in the engine bay of the vehicle.

QRS manufactures more than 600 firewall products for antique, classic, custom and street rod cars and trucks. The company has developed these products based on “out of car” original insulator pads that have been supplied by its customers. QuietRide Firewalls Insulators are exact reproductions of OEM products.

Most firewall insulators made between 1928 and the mid-1960s were constructed with an oil impregnated cardboard cover in combination with a number of insulation materials. In 1964 General Motors and Ford Motor Company began using a “spray-on” rubber material bonded to a thin layer of “shody” insulation.

All of the company’s firewall products are vacuum form molded to fit the firewall and transmission contours exactly. They are digitized and manufactured on its Flow Water Jet Cutting System for accurate fitting. Each firewall cover is backed with period correct insulation which could include a black fiberglass or HeatShield barrier insulation.

Firewall Colors and “Sheen”

Just a word about the “look” of your old firewall in comparison to a new one--you may note that the new firewall does not look the same as your original--because of the “sheen.” The firewall insulator in a car built in the 1930s or 40s is now at least 70-80 years old and is dirty and dingy. When the vehicle came off the assembly line, all of its component parts were crisp, clean and sparkling fresh.

With few exceptions, firewall insulators were black when they came from the factory. There were some exceptions in the General Motors product line from 1933 through 1941 in which the firewall insulators were a “mocha brown” color. The firewall color would typically match the color of your clutch, brake and accelerator pedal rubber pads.



3183 Hwy 71 S, Mena, AR 71953

Order Line: 888-777-3410

Tech Line (209) 942-4777

Fax (877) 720-2360

©2003-21 Quiet Ride Solutions LLC.

“AcoustiSHIELD” --- “Quiet Ride Solutions” “AcoustiTRUNK” ---”ShowBEDDER” ---”AcousatiHOOD”are Registered Trade Marks of Quiet Ride Solutions LLC.

Mounting Pins and Clips

American Cars and Trucks used a wide variety of mounting pins, clips, buttons and screws to attach the firewall insulator to the interior of the steel firewall bulkhead. Clean up and reuse your original mounting pins if you have them. We offer the following mounting pins and information based on what we have been able to find available.

UMPS-10	Universal Mounting Pins If your original firewall mounting pins are missing or damaged beyond repair, these universal pins may be a solution. They are a plastic "Christmas tree" type pin with a 1/2" button "head" that will fit most 5/16 inch holes. Kit includes 10 pins.	20
UWC-MPL-10	Universal Wire Cap Mounting Pin--Long A variety of car and truck manufacturers in the 1930s-40s-50s used a wire cap retainer to mount the firewall insulator. Long shank (1/2 inch) with a 1/2 inch button "head" that can be painted to match the firewall color. Kit includes 10 Pins.	10
UWC-MPS-10	Universal Wire Cap Mounting Pin--Short A variety of car and truck manufacturers in the 1930s-40s-50s used a wire cap retainer to mount the firewall insulator. Short shank (1/4 inch) with a 1/2 inch button "head" that can be painted to match the firewall color. Kit includes 10 Pins.	10
UPPS-20	Universal Upholstery Panel Pin Set If your original upholstery panel mounting pins are missing or damaged beyond repair, these universal pins may be a solution. They are a short-shank plastic "Christmas tree" type pin with a 1/2 inch "head" that will fit 5/16 inch holes. Kit includes 10 pins.	30
FORD 3541-MPL	Early Ford Firewall Mounting Pins--Long These all steel firewall mounting pins are an exact reproduction of the originals. They are in a 3/4 inch in length. The Long pin works best in the 1935-41 cars and may be used on cars through the mid-fiftys.	3
FORD 3541-MPS	Early Ford Firewall Mounting Pin--Short These all steel firewall mounting pins are an exact reproduction of the originals. They are in a 1/2 inch in length. The short pins work best for the 1942-48 Ford cars and 1940-47 Ford trucks and may be used on trucks through the mid-fiftys.	3
FORD RB-MP	Late Model Ford Firewall Mounting Pins--Rubber Bullet Style These all Rubber Bullet Style Ford mounting pins were used on FOMOCO products starting in 1969. These are an exact reproduction of the original.	3
GM 5500-MP	GM Firewall Plastic Firewall Mounting Plugs General Motors started using a plastic firewall mounting plug to attach the insulator to the steel firewall bulkhead in 1955 for trucks and 1957 for cars. These plugs are still used in many GM vehicles today.	3
SRMP-9	Street Rod Mounting Pin Kit With this new mounting pin kit, you can smooth your firewall by welding closed the firewall mounting holes and install any of our insulator panels for that "smoothie look." This kit will give you the option to place the firewall mounting pins where they will fit your application best. Be sure to order your firewall insulator "No Holes" when you place your order. Kit Includes 9 pinsets and instructions.	34
R-83-56	Early and Mid-Year 1932 Ford Correct insulator panel to dash mounting screws for early and mid-year 1932 passenger car, wagon and sedan delivery. Per Ford Engineering release documents, the correct slotted flat head screws (1/4-20 x 1 3/16), locks, hex nuts and cup washers. Finished in black oxide. Kit includes 12 Sets (48 pieces.) Please Order directly from https://thirdgenauto.com/ford-bolts/	14.95
R-07-01	Ford Original Shoulder Bolts for mid-to-late 1932 through 1935 Cars/Trucks Ford special slotted truss head shoulder screw, painted in Ford S-2 finish. Period correct insulator panel to dash Truss head/Shoulder mounting bolts for mid-to-late 1932-35 car, wagon and sedan delivery. Per Ford Engineering release documents. Kit includes one Shoulder screw, 1/4 lock and 1/4-20 hex nut. FYI: 12 required for 1932 Vehicles and 14 required for 1933-35 vehicles. Please Order directly from https://thirdgenauto.com/ford-bolts/	5.95

